

Portable Configurable Zigbee Green Power Switch

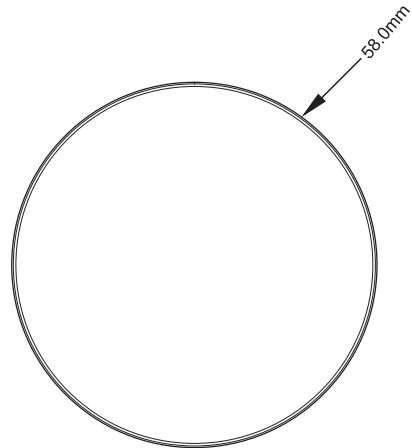

Important: Read All Instructions Prior to Installation

Function introduction



Front side

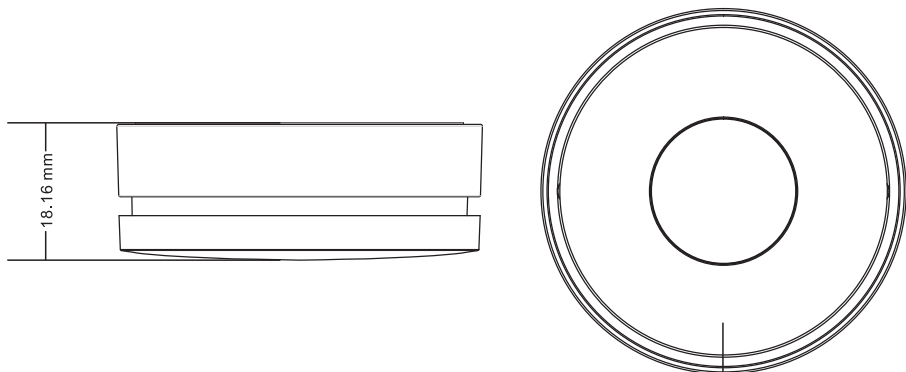

The remote control can be fixed on the wall with 3M glue or absorbed on the metal surface with built-in magnet

Back side

Product Data

Switch Type	Configurable Zigbee Green Power Switch
Transmission Range	10-30m (typical)
Radio Frequency	2.4GHz
Power Supply	Self-generated when switch is pressed
Buttons	1
Dimensions	Φ58*H18.16mm
Operating Temperature	-20 °C ~ +45 °C
Working Humidity	10% ~ 95% RH non-condensing
Waterproof Grade	IP20
Warranty	5 years

Product Description

The portable Zigbee Green Power switch is a wireless transmitter that communicates with Compatible Zigbee hub. The switch uses battery-free, energy-harvesting technology. Every time the switch is pressed, a micro-generator produces a small electrical current that powers a built-in transmitter. This transmitter sends wireless radio signals that are used to remotely control the compatible Zigbee system.

The switch can be configured through Zigbee App after added to the Zigbee hub. This switch has one button to trigger different actions of designated devices or zones with 3 events: short press, double click, long press. Action of each event and controlled object of the button can be configured through Zigbee App.

Safety & Warnings

- DO NOT expose the device to moisture.

Operations

1. Add the Switch to a Compatible Zigbee Hub (For instance Azoula Smart Hub and Azoula Smart App)

Step 1: tap on "+" button on "Home" page, then tap on "Zigbee-Green Power" to add Green Power switch.

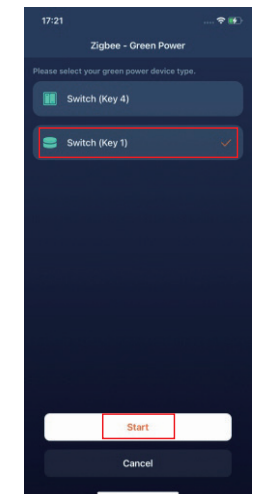
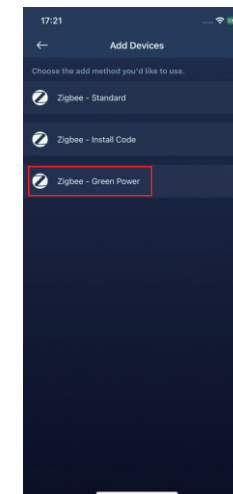
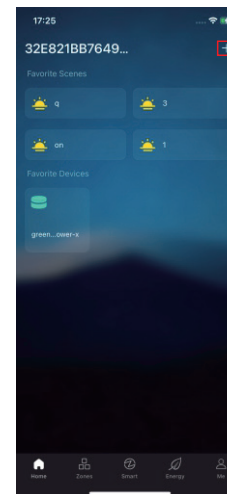

Step 2: tap on "Switch (Key 1)", then tap on "Start" button to add 1 key Green Power switch.

Step 3: Follow the instructions of the App to operate the switch and add it to the App.

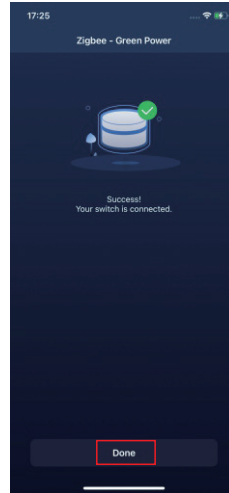
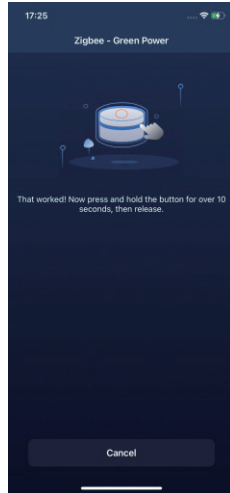
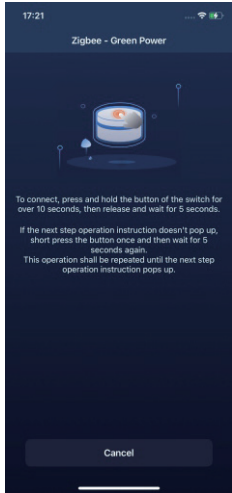

Step 4: Once added successfully, tap on "Done" button to finish adding.

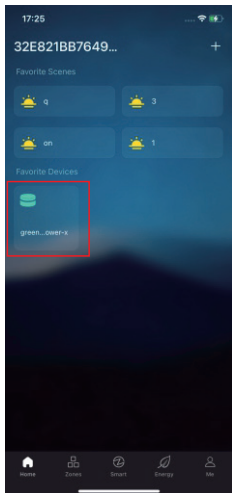

Step 5: The added switch will be shown on the "Home" Page.

2. Configure the switch through a Compatible Zigbee Hub (For instance Azoula Smart Hub and Azoula Smart App)

After the switch is added to the hub, navigate to "Smart" Page of the Azoula Smart App and you can use the switch to set "Automation". Please refer to the user manual of Azoula Smart Hub to learn how to set automation using green power switch.