

Zigbee Compatible Fixture Integrated Occupancy Sensor



Product Info

Network indicator: indicates when commissioning the device, stays on if not added to a Zigbee network, stays off after added to Zigbee network.

Program key: for Zigbee commissioning such as network pairing, touchLink, factory reset etc.

Daylight sensor: detects ambient light.

Microwave sensor indicator: indicates when motion detected.

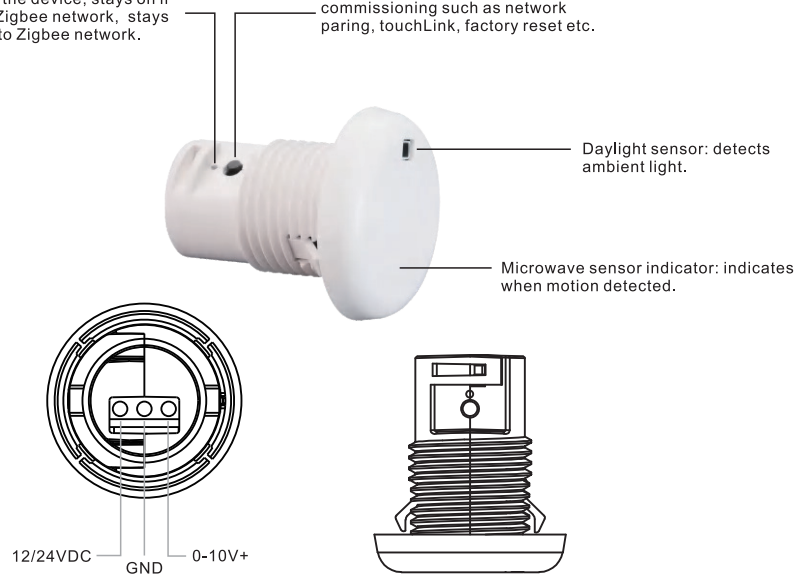

Product Description

The fixture-Integrated sensor combines occupancy sensing, daylight harvesting, 0-10V dimming and Zigbee radio circuits into a small package that fits into various luminaires. When used with 0-10V dim-to-off LED drivers, it enables any lighting manufacturer to deliver wirelessly-controllable and sensor-equipped fixtures with minimal engineering effort. The sensor-equipped luminaires just need to be connected to mains power. The result is increased occupant comfort and significant energy savings that meet the most demanding building energy codes.

Commissioning

All setup is performed via supported IEEE 802.15.4-based control platforms and other Zigbee3.0 compatible lighting control systems. Appropriate gateway control software allows for adjustment of motion sensitivity, dimming level, Detection area, time delay and daylight threshold.

After it is commissioned with a compatible gateway, the sensor can be programmed to apply 100% dimming to Dim-to-Zero compatible 0–10V dimmable lights when motion is detected. When motion is no longer detected and the standby time delay expires, lights can be dimmed according to a set level and can be dimmed to zero/off after a dimming time delay expires. All aspects and sequence of operations are configurable via the gateway.

Parameters

Physical Information

Dimensions / Weight	See Dimensions / 12.3g (without locknut) / 21.3g (with locknut)
Mounting (Luminaire Hole)	1/2" trade size knockout (22.2-22.3mm)
Material / Color	ABS / White
Connectors / Wire Gauge	3 pin connectors / 24-18 AWG (0.2-0.75 mm ²)
Strip Length	0.28-0.35 in. / 7-9 mm

Electrical Information

Input Voltage	12/24 VDC
Current Consumption	< 30mA (when dimming method = sink)
Dimming Control	Analog (0-10V)
Dimming Output	4mA (sink) / 20mA (source)
Status Indicators	Red (zigbee network status), Red (occupancy detection)

Wireless Communication

Radio Frequency	2.4 GHz
Wireless Protocol	Zigbee 3.0
Wireless Range	100 feet (30m) Line of Sight
Radio Certification	FCC/IC, CE

Lighting Control

Features	Continuous dimming , Individual/group addressing, Scene control, Task tuning (0-100%) Autonomous sensor-based control, Scheduler control
----------	--

Environment

Operating Temperature Range	32°F to 104°F / 0°C to 40°C (indoor use only)
Operating Humidity	0-95% (non condensing)
Safety Certification	cULus Listed, CE

Zigbee Compatible Fixture Integrated Occupancy Sensor

Sensing

Occupancy Sensing Type	Microwave sensor
Microwave High Frequency	5.8 GHz \pm 75 MHz ISM band
Detection Sensitivity	0-15, 0 is 100% the max. sensitivity, 15 is the min. sensitivity
Lux Detection Range	0-1000 Lux
Mounting Height	Up to 10ft (2.5m)
Detection Angle	150° (wall), 360° (ceiling)
Sensing Information	Can be shared within Zigbee mesh network

Features

Key Features

- Zigbee 3.0 compliant
- Microwave motion detection
- Daylight harvesting
- Task tuning
- Compact form factor
- Works with 0-10V dim-to-off LED drivers
- Autonomous sensor-based control
- OTA firmware upgrade

Benefits

- Cost-effective solution for energy savings
- Energy code compliance
- Fits into existing and new-design luminaires
- Robust mesh network
- Compatible with universal Zigbee platforms that support sensor

Applications

- Open offices
- Individual offices
- Conference rooms
- Classrooms
- Retail stores
- Hospitals
- Lobbies

Operation

1.Endpoints Description

This device is with 2 endpoints:

Endpoint 1: device type is dimmable light (0x0101)

Endpoint 2: device type is occupancy sensor (0x0107)

2.Zigbee Network Pairing

Step 1: From your ZigBee gateway or hub interface, choose to add lighting device and enter Pairing mode as instructed by the gateway.

Step 2: Short press the “Prog.” Button 5 times continuously (or reset power of the device 5 times), the device will be reset to factory default and enter into network pairing mode which lasts for 15 seconds. Once timeout, repeat this step.

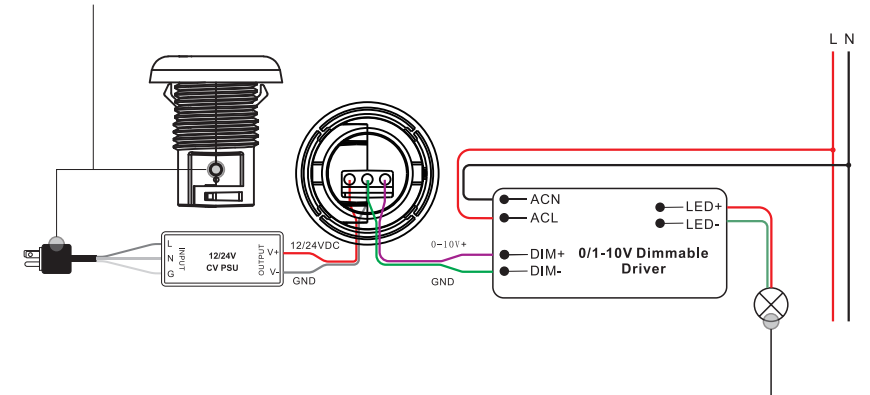

Step 3: The LED indicator and the connected 1-10V dimmable LED will blink 5 times, then the device will appear in your gateway's menu and can be controlled through gateway or hub interface.

3.TouchLink to a Zigbee Wireless Switch

Step 1: Method 1: Short press “Prog.” button 4 times (or reset power of the device 4 times) to start Touchlink commissioning immediately, 180S timeout, repeat this step.

Method 2: Reset power of the device, Touchlink commissioning will start after 15S if it's not added to a zigbee network, 165S timeout. Or start immediately if it's already added to a network, 180S timeout. Once timeout, repeat this step.

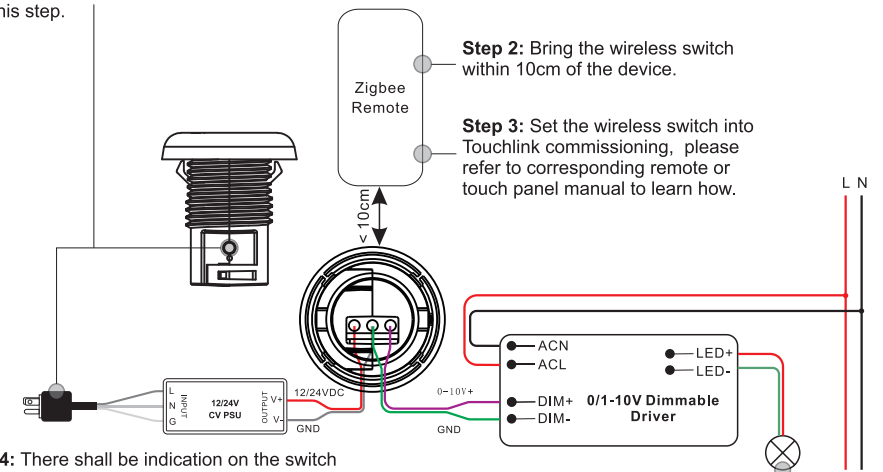

Step 4: There shall be indication on the switch for successful link and connected light will flash twice.

Zigbee Compatible Fixture Integrated Occupancy Sensor

- Note:**
- 1) Directly TouchLink (both not added to a ZigBee network), each device can link with 1 switch.
 - 2) TouchLink after both added to a ZigBee network, each device can link with max. 30 switches.
 - 3) To control by both gateway & switch, add switch and device to network first then TouchLink.
 - 4) After TouchLink, the device can be controlled by the linked switches.

4.Active Touchlink to a Zigbee Light Device

Step 1: Set the zigbee light device to start TouchLink commissioning, please refer to its manual to learn how.

Step 3: Immediately short press the "Prog." Button twice to start Active Touchlink commissioning of the sensor. LED indicator flashes fast, then flash 6 times slowly to indicate successful pairing to the light device and the light device will blink twice.

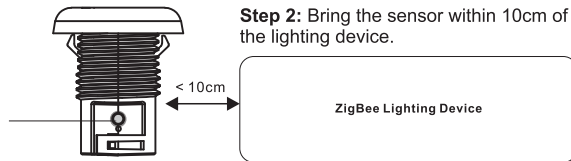

Step 2: Bring the sensor within 10cm of the lighting device.

Note: 1) Directly TouchLink (both not added to a ZigBee network), each sensor can link with 30 devices.

- 2) TouchLink after both added to a ZigBee network, each sensor can link with max. 30 devices.
- 3) To control the device by both gateway & sensor, add sensor and device to network first then TouchLink.
- 4) After TouchLink, the sensor can control the linked lighting devices.

5.Removed from a Zigbee Network

From your ZigBee controller or hub interface, choose to delete or reset the device as instructed. The connected 1-10V dimmable LED blinks 3 times to indicate successful reset.

6.Factory Reset Manually

Step 1: Short press "Prog." key for 5 times continuously or reset power of the device for 5 times continuously if the "Prog." key is not accessible.

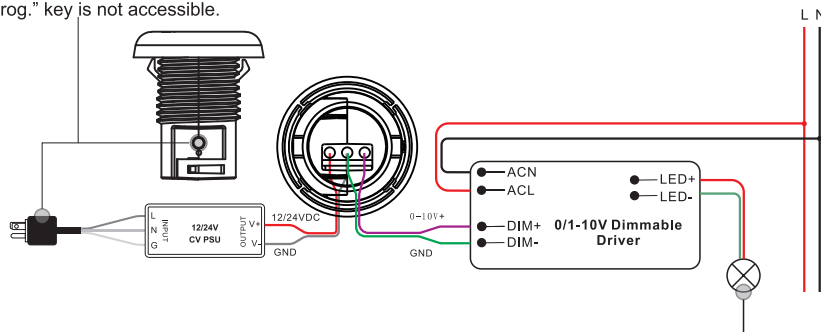

Step 2: Connected light will blink 3 times to indicate successful reset.

Note:

- 1) If the device is already at factory default setting, there is no indication when factory reset again .
- 2) All configuration parameters will be reset after the device is reset or removed from the network.

7.Factory Reset through a Zigbee Wireless Switch (Touch Reset)

Note: Make sure the device already added to a network, the wireless switch added to the same one or not added to any network.

Step 1: Short press "Prog." Button 4 times (or reset power of the device 4 times) to start TouchLink Commissioning, 180 seconds timeout, repeat this step.

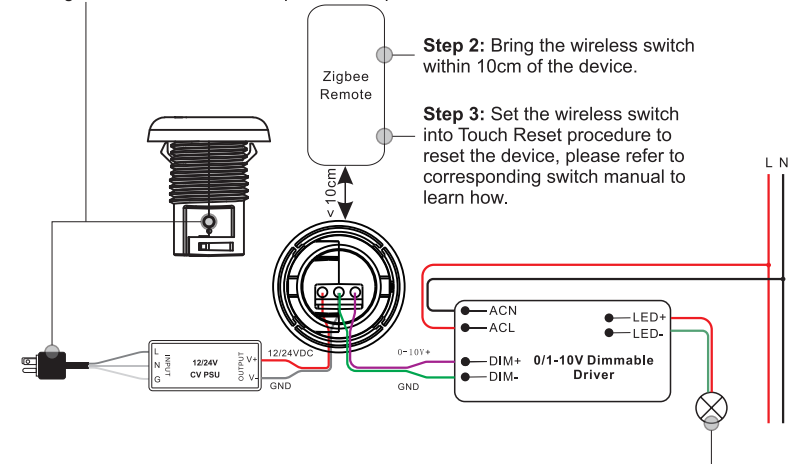

Step 2: Bring the wireless switch within 10cm of the device.

Step 3: Set the wireless switch into Touch Reset procedure to reset the device, please refer to corresponding switch manual to learn how.

Step 4: There shall be indication on the switch and connected 0-10V dimmable LED flashes 3 times for successful reset.

8.Find and Bind Mode

Note: Make sure the device and switch already added to the same zigbee network.

Step 1: Short press "Prog." button 3 times (Or reset power of the device (initiator node) 3 times) to start Find and Bind mode (connected 0-10V dimmable LED flashes slowly) to find and bind target node, 180 seconds timeout, repeat this step.

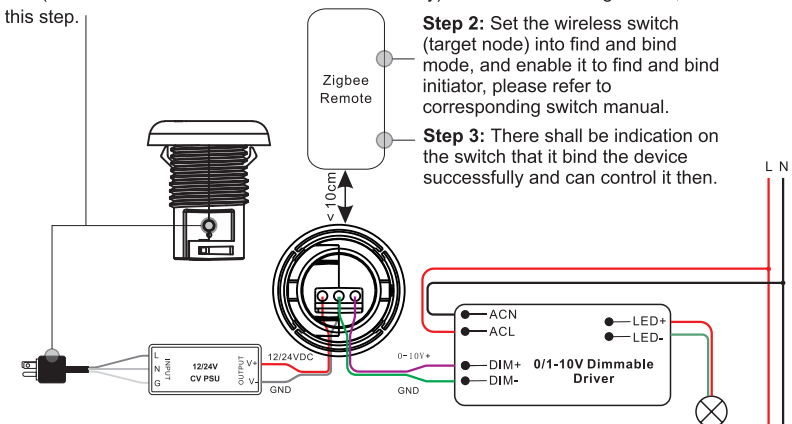

Step 2: Set the wireless switch (target node) into find and bind mode, and enable it to find and bind initiator, please refer to corresponding switch manual.

Step 3: There shall be indication on the switch that it bind the device successfully and can control it then.

Zigbee Compatible Fixture Integrated Occupancy Sensor

9. Learning to a Zigbee Green Power Switch

Step 1: Short press “Prog.” button 4 times (Or reset power of the device 4 times) to start Learning to GP switch mode (connected 0-10V dimmable LED flashes twice), 180 seconds timeout, repeat this step.

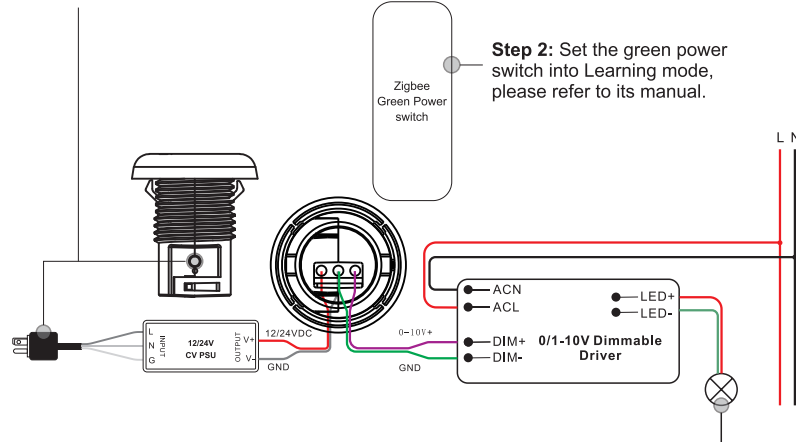

Step 2: Set the green power switch into Learning mode, please refer to its manual.

Step 3: Connected 0-10V dimmable LED will flash twice to indicate successful learning. Then the switch can control the device.

Note: Each device can learn to max. 20 zigbee green power switches.

10. Delete Learning to a Zigbee Green Power Switch

Step 1: Short press “Prog.” button 3 times (Or reset power of the device 3 times) to start delete Learning to GP switch mode (connected light flashes slowly), 180 seconds timeout, repeat this step.

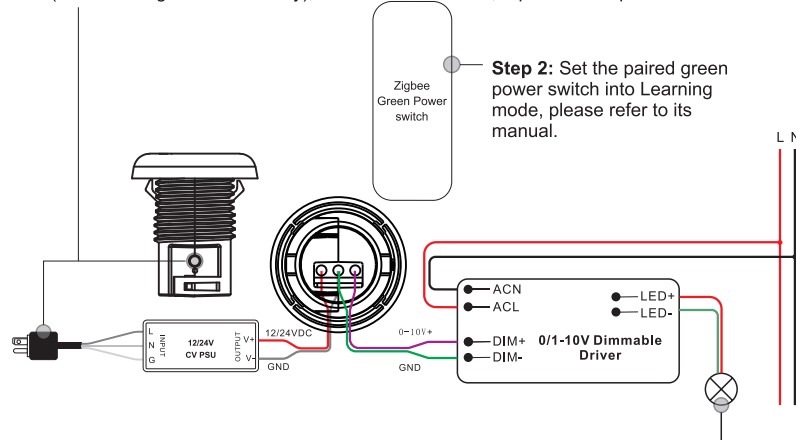

Step 2: Set the paired green power switch into Learning mode, please refer to its manual.

Step 3: Connected 0-10V dimmable LED will flash 4 times to indicate successful deleting.

11. Setup a Zigbee Network & Add Other Devices to the Network (No Coordinator Required)

Step 1: Short press “Prog.” button 4 times (Or reset power of the device 4 times) to enable the device to setup a zigbee network (connected light flashes twice) to discover and add other devices, 180 seconds timeout, repeat this step.

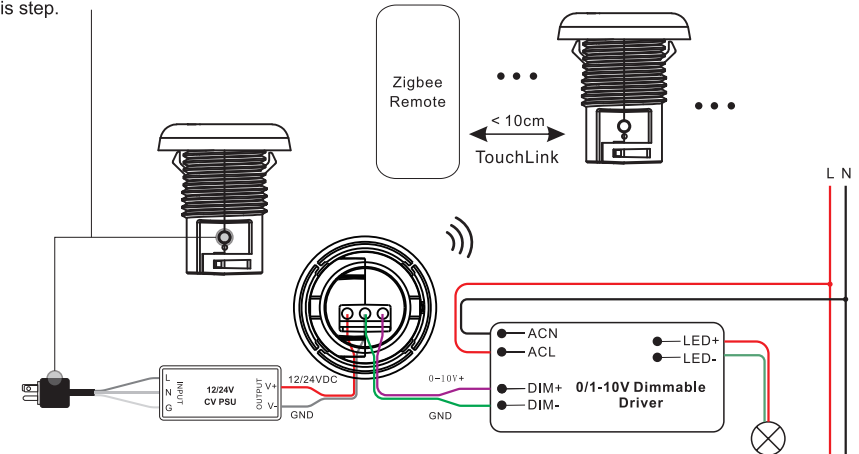

Step 2: Set another light device or wireless switch into network pairing mode and pair to the network, refer to their manuals.

Step 3: Pair more light devices and switches to the network as you would like, refer to their manuals.

Step 4: Bind the added light devices and switches through Touchlink so that the devices can be controlled by the switches, refer to their manuals.

Note: 1) Each added light device can link and be controlled by max. 30 added switches.

2) Each added switch can link and control max. 30 added light devices.

12. OTA

The device supports firmware updating through OTA, and will acquire new firmware from zigbee gateway or hub every 10 minutes automatically.

13. How to Check Whether the Device already Added to a Network or not

Method 1: Power on the device, if LED indicator turns on, the device has not been added to a network, if LED indicator stays off, the device has already been added to a network.

Method 2: Power on the device, if the connected 0-10 dimmable LED is under fade in and fade out status, the device has not been added to a network, if connected 0-10 dimmable LED stays solid on, the device has already been added to a network.

14. Supported Zigbee Clusters

The gateway can use zigbee standard command Simple description request to read the clusters supported by this device.

Endpoint 1:

Input Clusters:

Zigbee Compatible Fixture Integrated Occupancy Sensor



0x0000: Basic
 0x0003: Identify
 0x0004: Groups
 0x0005: Scenes
 0x0006: On/off
 0x0008: Level Control
 0x0b05: Diagnostics
 0x0100: zll commissioning
 Output Clusters:
 0x0019: OTA
 0x0100: zll commissioning

Endpoint 2:

Input Clusters:
 0x0000: Basic
 0x0003: Identify
 0x0400: illuminance measurement
 0x0406: occupancy sensing
 Output Clusters:
 Proprietary attributes:

Cluster	Attributes	Data type	Data description	Data default
0x0000	0x9000	0x20	How many times will the device search and join a Zigbee network, searching every 15 seconds. Valid value: 1~255 Default value is 2, which means searching 2 times, setting the value as 255 means always searching until the device is added to a network.	2
0x0000	0x9001	0x21	Light PWM Frequency Works after reset power of the device, the device that directly outputs PWM can be configured, DO NOT set the PWM frequency too high which will affect the dimming resolution.	3300
0x0000	0x9002	0xf1 (security key, 16bytes)	Install code For instance the returned value is 01 23 45 67 89 ab cd ef 01 23 45 67 89 ab cd ef App also displays 01 23 45 67 89 ab cd ef 01 23 45 67 89 ab cd ef	0x0123456789abcdef0123456789abcdef
0x0000	0x9003	0x21	Manufacturer id, Works after reset power of the device, Manufacturer id=0xffff means this attribute does not work, Manufacturer id is determined by SDK. Sunricher:0x1224	0xffff

0x0000	0x8806	0x20	Dimming brightness curve, Works after reset power of the device, 0x00: linear, 0x0f: logarithmic with gamma value 1.5, 0x12: logarithmic with gamma value 1.8	0x00
0x0006	0x4003	0x30	Start up on off, Device status after power reset, this attribute is a Zigbee standard optional attribute, 0x00: off, 0x01: on, 0xff: status before power reset	0xff
0x0000	0x8903	0x21	Motion sensor daylight sensor lux threshold, 2 bytes, only when the detected lux is lower than the threshold, turning on the light is permitted, for instance 0x0000, this function does not work.	0x0000
0x0000	0x8904	0x20	Motion sensor operation mode, 1 byte, 0x00: means auto mode, 0x01: means manual mode, Auto mode means that when a motion is detected, the device will output PWM according to the set brightness threshold, and delay time. PWM status needs to be reported to the gateway. Manual mode means that PWM output is controlled and determined by the gateway or the wireless switch, not associated with motion detection.	0x00
0x0000	0x8905	0x20	Motion sensor sensitivity setting, Works after reset power of the device, 1 byte, data range 0-15, 0 is the highest sensitivity, 15 is the lowest sensitivity.	0x01
0x0000	0x8906	0x20	Motion sensor microwave detection enabled or disabled, Works after reset power of the device, 1 byte, 0x00: disabled, 0x01: enabled	0x01
0x0000	0x8907	0x20	Configuration of whether to send ON/OFF command to the touchlink devices and binding devices, Works after reset power of the device, 0=do not send, 1=send	0x01

Zigbee Compatible Fixture Integrated Occupancy Sensor



0x0000	0x890c	0x20	Configuration of whether to enable the brightness module, 0=disabled, 1=enabled	0x01
0x0000	0x8902	0x21	Light on time (the first delay time), Works after reset power of the device, When motion sensor mode is set as auto mode, and motion is detected, after the person leaves, light on time of the device, 2 bytes, unit is second, For instance 0x003c means 60 seconds.	0x003c
0x0000	0x8908	0x21	Configuration of the brightness value of PWM output when motion detected, this brightness value is controlled through PWM output working as PID closed loop control to achieve the constant light output. Value range is 0-1000LUX, 0LUX means this attribute is disabled, and PWM output when motion detected is not associated with the brightness value.	0x0000
0x0000	0x8909	0x20	Configuration of PWM output percentage when motion detected, Value Range is 0x00-0xfe, which means 0-100%, When configured PID closed loop control brightness LUX is 0, PWM output of the device is according to this value.	0xfe
0x0000	0x890a	0x20	After the light on time expires, the light status within the duration of 2 nd delay time, Value range is 0x00-0xfe, which means 0-100%.	0x00
0x0000	0x8901	0x21	After the light on time expires, the duration of 2 nd delay time, Value range is 0-65536S.	0x003c
0x0000	0x890b	0x20	After the 2 nd delay time expires, the status of the light, Value range is 0x00-0xfe, which means 0-100%.	0x00

0x0000	0x890D	0x21	Linearity error ratio coefficient of LUX measurement: M Default value is 1000, which means 1000%. When increase the value of M, LUX measurement value will be magnified linearly. When decrease the value of M, LUX measurement value will be minified linearly. For instance, modify M value as 1001, LUX measurement value will be magnified to 1.001 times. Modify M value as 500, LUX measurement value will be magnified to 0.5 times.	0x03E8
0x0000	0x890E	0x29	Fixed deviation of LUX measurement, this parameter data type is INT, i.e. 2 bytes signed shaping For instance, if we need to increase the measurement value by 100LUX, then this parameter value will be +100, i.e. 0x0064. If we need to decrease the measurement value by 100LUX, then this parameter value will be -100, i.e. 0xFF9C.	0x0000

Note: the values of all above proprietary attributes can be modified by Zigbee gateway through the way of writing attributes.

Modify Attributes' Value through Smart Phone Bluetooth

The values of all above proprietary attributes can also be modified by connecting a smart phone and the device through Bluetooth and our proprietary protocol.

You just need to download a smart phone APP "**Sensor Tools**" and connect the smart phone and the device through BLE on the APP. The APP can be downloaded from **APP Store** and **Google Play Store** by searching the keyword "**Smart Sensor Tools**".

Please refer to the following operation steps to modify the attributes' value:

Step 1: Download the "Sensor Tools" APP and run it on the smart phone. Please allow the APP to access Location and enable Bluetooth on the smart phone.

Zigbee Compatible Fixture Integrated Occupancy Sensor

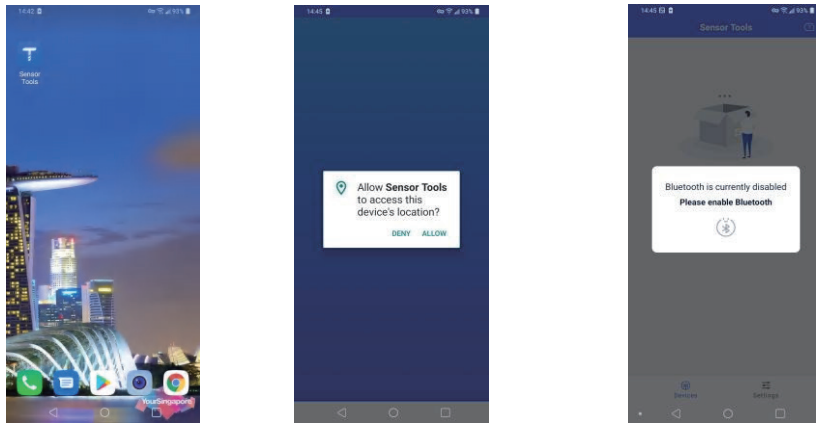

Step 2: Wire up the device and power on the device according to the wiring diagram.

Step 3: The device will be discovered by the APP automatically, then tap the device name to connect it to the smart phone through APP. Once connected successfully, all attributes of the device can be accessed.

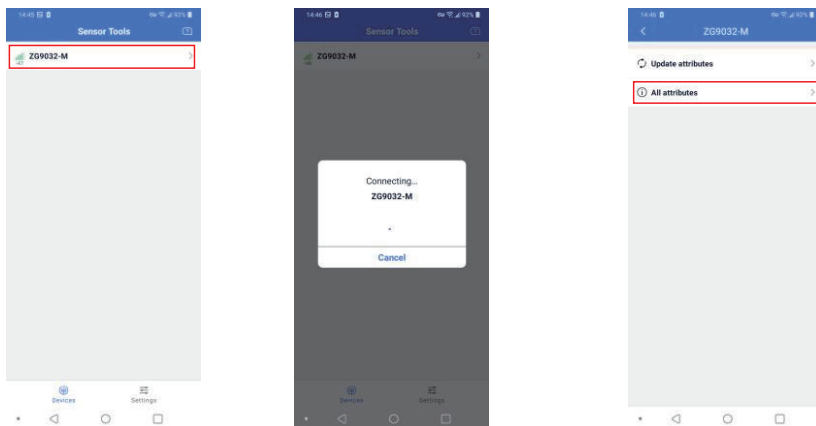

Step 4: Tap "All attributes" to access the list of all attributes. Then tap the name of an attribute to select it and enter modification interface, for instance "Pairing duration". Then tap "New value" to enter value edit page.

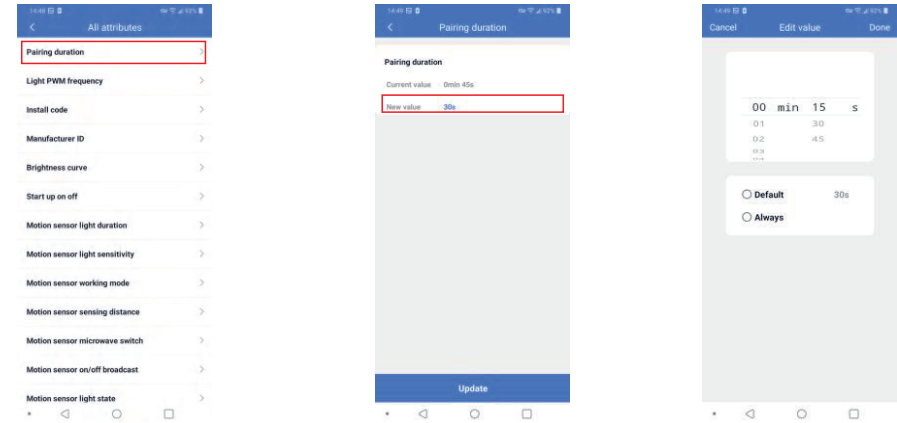

Step 5: Once a new value is set, tap "Done" at the upper right corner. Then tap "Update" button to update to the new value. Then tap "OK".

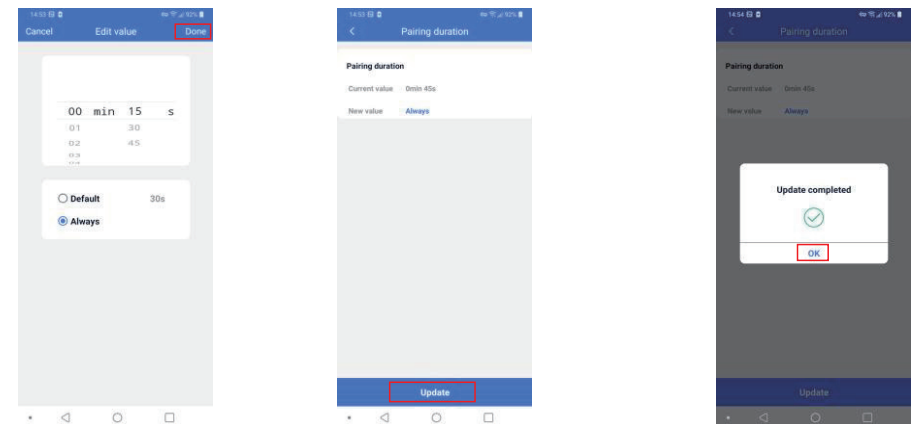

Step 6: Once an attribute is modified successfully, you can set another attribute following above steps. The modified values of some attributes work after power reset of the device, please refer to above detailed attributes' information in the table.

All Available Attributes as Follows:

- 1. Pairing duration:** the time that Zigbee network pairing mode lasts, value range: 15S – 63min 30S – Always, factory default is 30S.
- 2. Light PWM frequency:** value range: 0-65535, factory default is 3300.
- 3. Install code:** This attribute can not be modified.
- 4. Manufacture ID:** value range: 0x0000-0xFFFF, Sunricher, Philips, factory default is 0xFFFF.

Zigbee Compatible Fixture Integrated Occupancy Sensor

- 5. **Brightness curve:** value range: Linear, Gamma logistics 1.5, Gamma logistics 1.8, factory default is Linear.
 - 6. **Start up on off:** value range: The last state, On, Off, factory default is "The last state".
 - 7. **Motion sensor light duration:** value range: 0h 0min 0s – 18h 12min 15s, factory default is 5s.
 - 8. **Motion sensor light sensitivity:** value range: 0 – 65535, factory default is 0.
 - 9. **Motion sensor working mode:** value range: Automatic, Manual, factory default is Automatic.
 - 10. **Motion sensor sensing distance:** value range: 00-15, factory default is 01.
 - 11. **Motion sensor microwave switch:** value range: On, Off, factory default is On.
 - 12. **Motion sensor on/off broadcast:** value range: On, Off, factory default is On.
 - 13. **Motion sensor light state:** value range: On, Off, factory default is On.
 - 14. **Motion sensor IN PWM brightness:** value range: 0-1000, factory default is 0Lux.
 - 15. **Motion sensor IN PWM output:** value range: 0-254, factory default is 254.
 - 16. **Motion sensor LEAVE PWM output:** value range: 0%-100%, factory default is 0%.
 - 17. **Motion sensor LEAVE delay:** value range: 0h 0min 0s – 18h 12min 15s, factory default is 0s.
 - 18. **Motion sensor PWM output after delay:** value range: 0%-100%, factory default is 0%.
 - 19. **Linear error ratio coefficient of LUX measurement:** value range: 100‰ - 10000‰, factory default is 1000‰.
 - 20. **Fixed deviation of LUX measurement:** value range: -32768~32767, factory default is 0Lux.
- Note:** please refer to above proprietary attributes table in the part "proprietary attributes" for detailed attribute information.

Detection Area

- Note:**
- 1) Following different detection areas are based on different installation heights & patterns.
 - 2) For all detection areas, the sensitivity is set to 0 the highest.
 - 3) For all detection areas, the movement speed is 0.2-0.3m/S.

Ceiling Pattern (Unit: m)
Installation Height: 2.5m

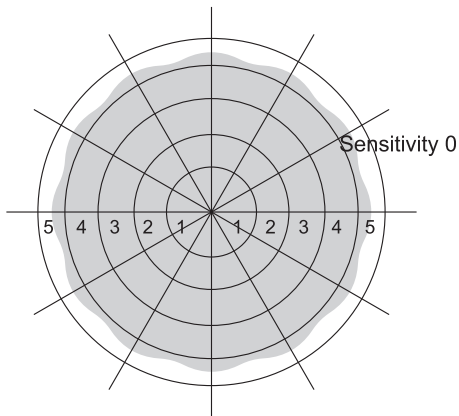

Wall Pattern (Unit: m)
Installation Height: 2.5m

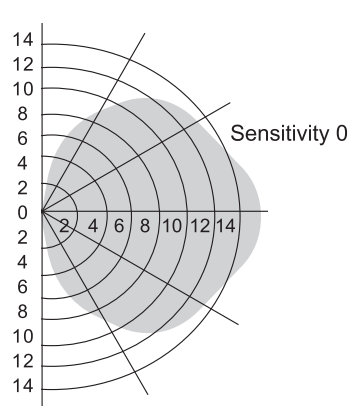

Ceiling Pattern (Unit: m)
Installation Height: 5m

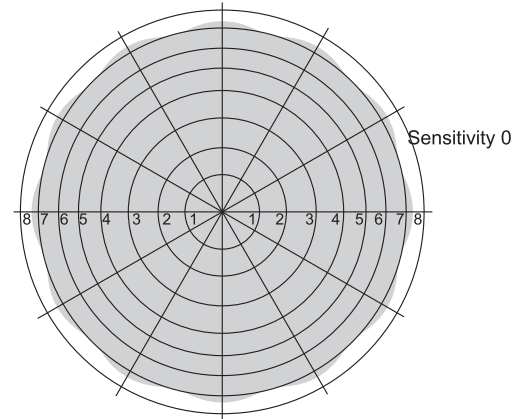

Wall Pattern (Unit: m)
Installation Height: 5m

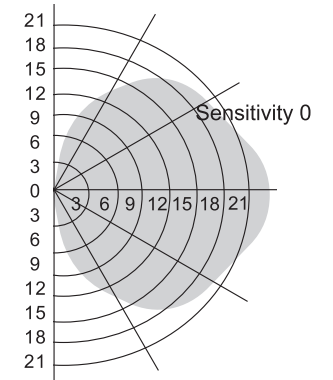

Ceiling Pattern (Unit: m)
Installation Height: 10m

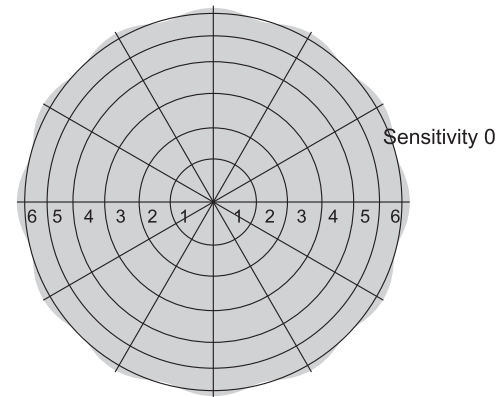

Wall Pattern (Unit: m)
Installation Height: 10m

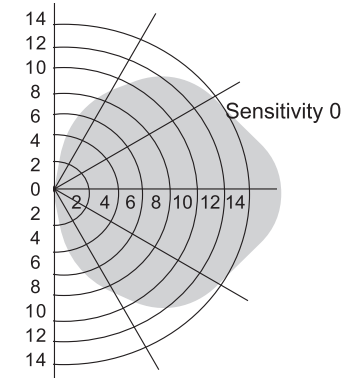

Zigbee Compatible Fixture Integrated Occupancy Sensor

Wiring

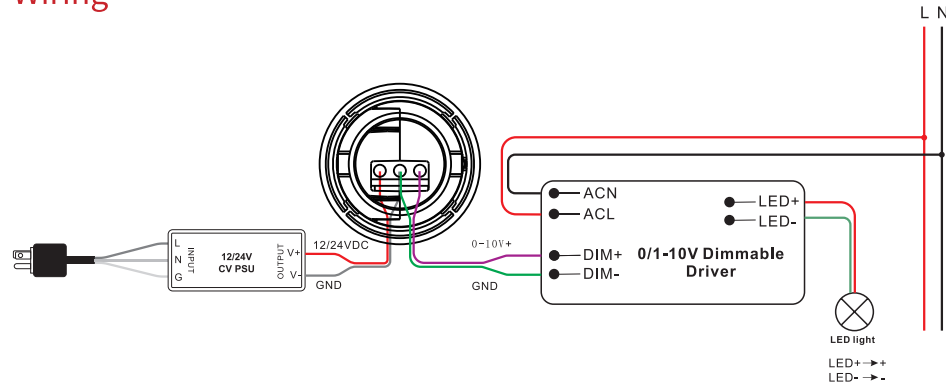

Dimension

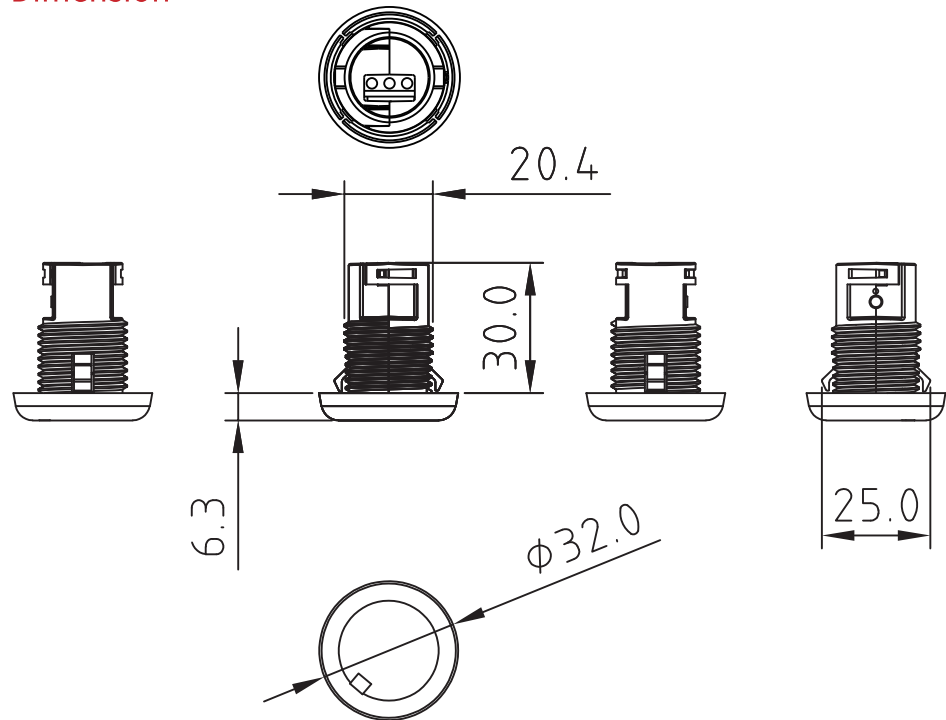

Installation Precautions

- Avoid areas with a lot of metal or concrete: Ensure the microwave part of the sensor is higher than any metal or shielding material.
- Avoid areas with moving objects: Such as electric fans, exhaust fans, drainage pipes, air conditioner outlets, elevators, pets, and insects.
- Avoid areas prone to vibration or resonance: Such as machinery, places where suspended sensors may vibrate, or areas with significant air convection.
- Avoid areas with materials that are easily penetrated: Microwave signals can pass through some plastic or paper materials, which may lead to false alarms in specific areas. Confirm the sensor's installation location and functional requirements beforehand.
- Avoid wave reflection: Different materials and exterior walls may cause wave reflection, leading to unnecessary false alarms.