

Push Compatible ZigBee Keypad Smart Dimmer



Important: Read All Instructions Prior to Installation

Function introduction

On and dim up button, short press to turn on load, press and hold to increase brightness

"Reset" Key: for zigbee network pairing, touchlink or factory reset the device

LED indicator, stays off when power on the dimmer, turns on after added to a zigbee hub, indicates (same status as connected load) when program the dimmer (network pairing, touchlink, factory reset), indicates when the load is turned on/off, dimmed up/down

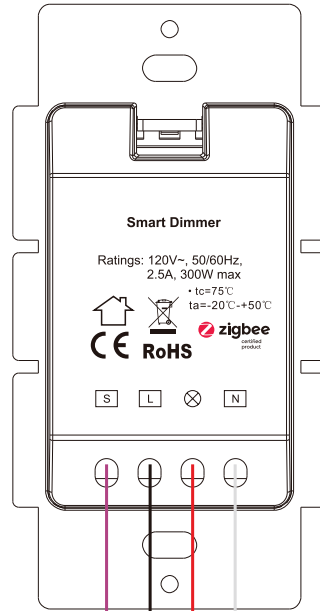
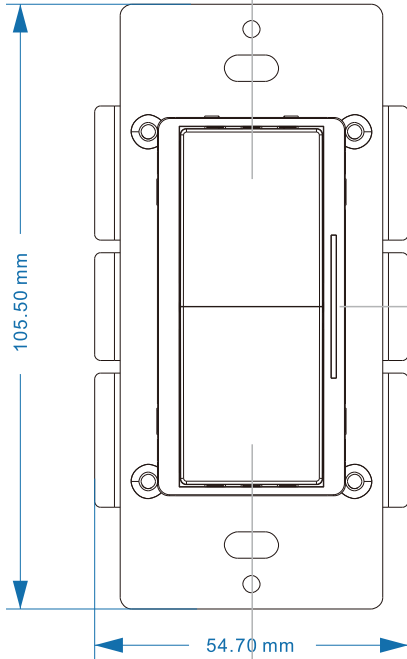

Off and dim down button, short press to turn off load, press and hold to decrease brightness

"Min. Set" key: 1) to set or delete a minimum brightness, 2) to set or delete a startup brightness

Front view

Back view

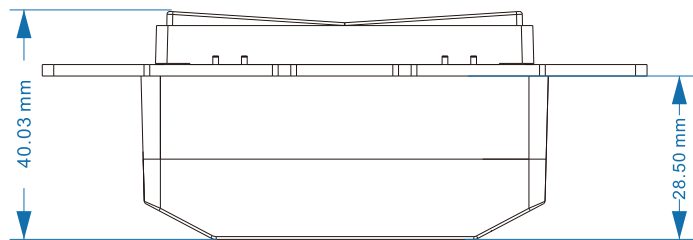

Side view

Product Data

Input Voltage	Output Voltage	Output Current	Size(LxWxH)	Ambient Temperature
120VAC	120VAC	2.5A max	105.5x54.7x40.03mm	-20°C ~ +50°C

Compatible Load Types

Load Symbol	Load Type	Maximum Load	Remarks
	Dimmable LED lamps	150W @ 120V	Due to variety of LED lamp designs, maximum number of LED lamps is further dependent on power factor result when connected to dimmer.
	Dimmable LED drivers	150W @ 120V	Maximum permitted number of drivers is 150W divided by driver nameplate power rating.
	Incandescent lighting, HV Halogen lamps	300W @ 120V	
	Low voltage halogen lighting with electronic transformers	300W @ 120V	

Status of Indication LEDs When the Load is Dimmed

Load Brightness	Status of Indication LEDs
Turned on	All LEDs turn on
Turned off	All LEDs turn off
Dimmed to the range 81%-99%	5 LEDs stay on
Dimmed to the range 61%-80%	4 LEDs stay on
Dimmed to the range 41%-60%	3 LEDs stay on
Dimmed to the range 21%-40%	2 LEDs stay on
Dimmed to the range 1%-20%	1 LED stays on

ZigBee Clusters the device supports are as follows:

Input Clusters

- 0x0000: Basic
- 0x0003: Identify
- 0x0004: Groups
- 0x0005: Scenes
- 0x0006: On/off
- 0x0702: Simple Metering
- 0x0008: Level Control
- 0x0b04: Electrical Measurement
- 0x0b05: Diagnostics

Output Clusters

- 0x0019: OTA

- ZigBee keypad smart dimmer based on latest ZigBee 3.0 protocol
- Can work under no neutral wiring and with neutral wiring, self-adaptive
- Supports resistive loads, capacitive loads or inductive loads
- Enables to set minimum brightness and startup brightness
- 1 channel output, up to 300W
- Both leading edge version and trailing edge versions are available for choosing, preset by factory setting
- Enables to control ON/OFF and light intensity of connected light source
- ZigBee end device that supports Touchlink commissioning
- Can be controlled by zigbee gateway, zigbee remote and local rotary knob
- Can directly pair to a compatible ZigBee remote via Touchlink without coordinator
- Supports self-forming zigbee network without coordinator and add other devices to the network
- Supports find and bind mode to bind a ZigBee remote
- Supports zigbee green power and can bind max. 20 zigbee green power switches
- Compatible with universal ZigBee gateway products
- With push switch input, can be controlled by universal AC push switches
- Standard size, can be compatible with existing US standard frames, and installed into existing junction box
- Radio Frequency : 2.4GHz
- Waterproof grade: IP20

Main Features:

- Can operate under two-wire connection with no neutral lead or three-wire connection with neutral lead
- Advanced microprocessor control
- Implemented algorithm of smart light source detection
- Active power and energy metering functionality
- Soft start function
- Innovative minimum dimming level and startup brightness setting functions
- The Bypass is an extension unit

As a dimmer it operates under the following loads:

- Conventional incandescent and HV halogen light sources
- ELV halogen lamps and dimmable LED bulbs (with electronic transformers)
- MLV halogen lamps (with ferromagnetic transformers)
- Dimmable LED bulbs
- Dimmable compact fluorescent CFL tube lamps
- Supported dimmable light sources (power factor > 0.5) with minimal power of 3VA using the Bypass (depending on the type of load)

Trailing edge or leading edge dimming mode can be set by factory setting to control following types of loads:

- "Trailing edge" for resistive loads
- "Trailing edge" for capacitive loads
- "Leading edge" for inductive loads

Note: factory default setting is trailing edge.

Safety & Warnings

- DO NOT install with power applied to device.
- DO NOT expose the device to moisture.

Operation

1. Do wiring according to connection diagram correctly.

2. This ZigBee device is a wireless receiver that communicates with a variety of ZigBee compatible systems. This receiver receives and is controlled by wireless radio signals from the compatible ZigBee system.

3. Zigbee Network Pairing through Coordinator or Hub (Added to a Zigbee Network)

Step 1: Remove the device from previous zigbee network if it has already been added to, otherwise pairing will fail. Please refer to the part "Factory Reset Manually".

Step 2: From your ZigBee Controller or hub interface, choose to add lighting device and enter Pairing mode as instructed by the controller.

Step 4: Connected light will blink 6 times and then stay solid on, then the device will appear in your controller's menu and can be controlled through controller or hub interface.

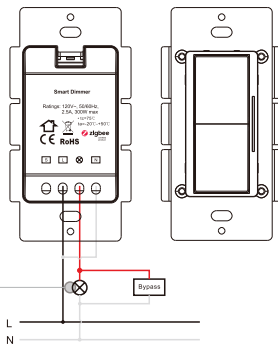

Step 3: power on the device, it will be set into network pairing mode automatically (connected light flashes twice slowly), the network pairing mode will last until the device is added to a zigbee network. If the connected light does not flash, please factory reset the dimmer first.

4. Removed from a Zigbee Network through Coordinator or Hub Interface

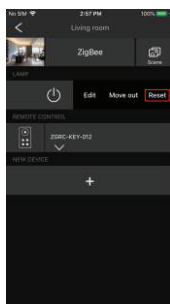

From your ZigBee controller or hub interface, choose to delete or reset the lighting device as instructed. The connected light blinks 3 times to indicate successful reset.

5. TouchLink to a Zigbee Remote

Step 1: Method 1: Short press "Reset" button 4 times and then within 2 seconds press and hold it for over 5 seconds to start Touchlink commissioning immediately under any circumstances, 180S timeout, repeat this step.

Method 2: Add the device to a gateway or hub network, it will be set into Touchlink commissioning immediately after added, 180S timeout. Once timeout, reset power of the device to set it into touchlink commissioning again.

Step 2: Bring the remote or touch panel within 10cm of the lighting device.

Step 3: Set the remote or touch panel into Touchlink commissioning, please refer to corresponding remote or touch panel manual to learn how.

Step 4: There shall be indication on the remote for successful link and connected light will flash twice.

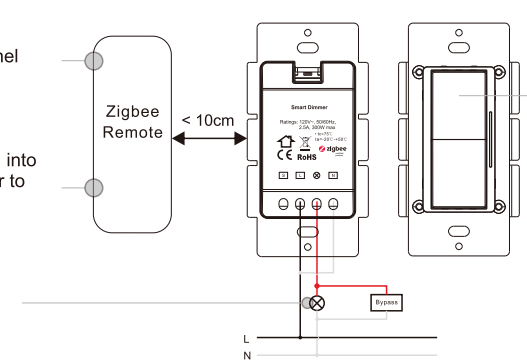

- Note:**
- 1) Directly TouchLink (both not added to a ZigBee network), each device can link with 1 remote.
 - 2) TouchLink after both added to a ZigBee network, each device can link with max. 30 remotes.
 - 3) Control with both gateway and remote, add remote and device to network first then TouchLink.
 - 4) After TouchLink, the device can be controlled by the linked remotes.

6. Factory Reset Manually

Note: 1) If the device is already at factory default setting, there is no indication when factory reset again .

2) All configuration parameters will be reset after the device is reset or removed from the network.

Step 2: Connected light will blink 3 times to indicate successful reset.

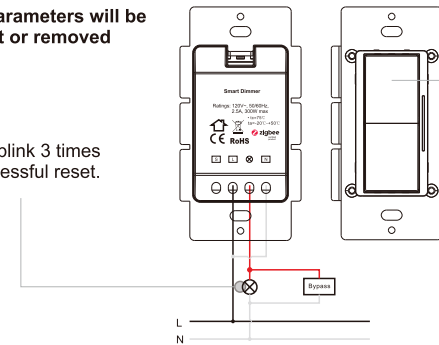

Step 1: Short press "Reset." key 5 times continuously and then within 2 seconds press and hold it for over 5 seconds.

7. Factory Reset through a Zigbee Remote (Touch Reset)

Note: Make sure the device already added to a network, the remote added to the same one or not added to any network.

Step 2: Bring the remote or touch panel within 10cm of the lighting device.

Step 3: Set the remote or touch panel into Touch Reset procedure to reset the device, please refer to corresponding remote or touch panel manual to learn how.

Step 4: There shall be indication on the remote and connected light flashes 3 times for successful reset.

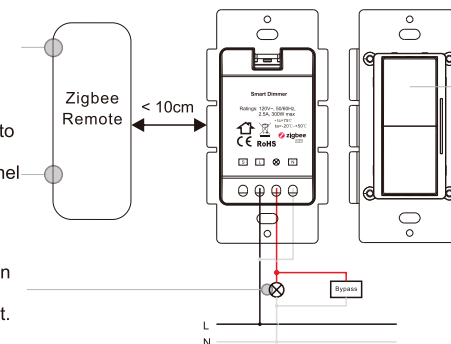

Step 1: Short press "reset" button 4 times and then within 2 seconds press and hold it for over 5 seconds to start TouchLink Commissioning, 180 seconds timeout, repeat this step.

8. Find and Bind Mode

Note: Make sure the device and remote already added to the same zigbee network.

Step 2: Set the remote or touch panel (target node) into find and bind mode, and enable it to find and bind initiator, please refer to corresponding remote or touch panel manual.

Step 3: There shall be indication on the remote or touch panel that it bind the device successfully and can control it then.

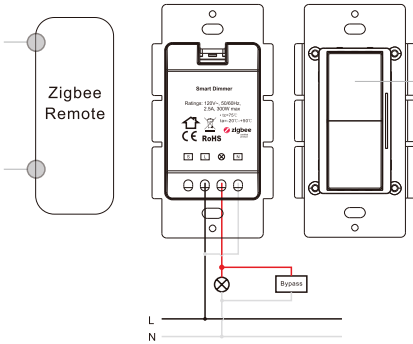

Step 1: Short press "Reset." button 3 times and then within 2 seconds press and hold it for over 5 seconds to start Find and Bind mode (connected light flashes slowly) to find and bind target node, 180 seconds timeout, repeat this step.

9. Learning to a Zigbee Green Power Switch

Step 2: Set the green power switch into Learning mode, please refer to its manual.

Step 3: Connected light will flash twice to indicate successful learning. Then the switch can control the device.

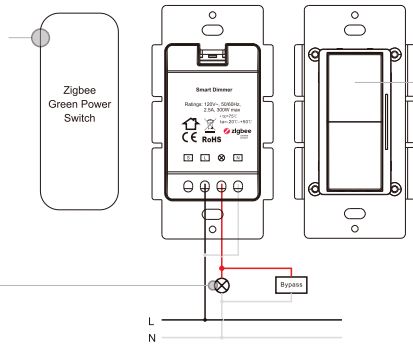

Step 1: Short press "Reset." button 4 times and then within 2 seconds press and hold it for over 5 seconds to start Learning to GP switch mode (connected light flashes twice), 180 seconds timeout, repeat this step.

Note: Each device can learn to max. 20 zigbee green power switches.

10. Delete Learning to a Zigbee Green Power Switch

Step 2: Set the paired green power switch into Learning mode, please refer to its manual.

Step 3: Connected light will flash 4 times to indicate successful deleting.

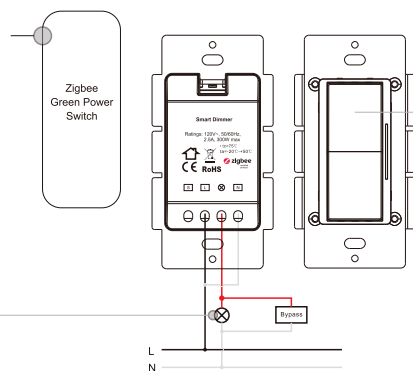

Step 1: Short press "Reset." button 3 times and then within 2 seconds press and hold it for over 5 seconds to start delete Learning to GP switch mode (connected light flashes slowly), 180 seconds timeout, repeat this step.

11. Setup a Zigbee Network & Add Other Devices to the Network (No Coordinator Required)

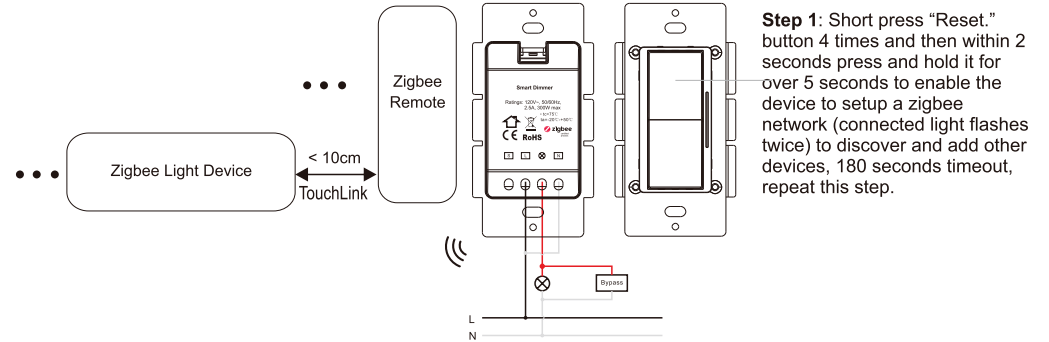

Step 1: Short press "Reset." button 4 times and then within 2 seconds press and hold it for over 5 seconds to enable the device to setup a zigbee network (connected light flashes twice) to discover and add other devices, 180 seconds timeout, repeat this step.

Step 2: Set another device or remote or touch panel into network pairing mode and pair to the network, refer to their manuals.

Step 3: Pair more devices and remotes to the network as you would like, refer to their manuals.

Step 4: Bind the added devices and remotes through Touchlink so that the devices can be controlled by the remotes, refer to their manuals.

Note: 1) Each added device can link and be controlled by max. 30 added remotes.
2) Each added remote can link and control max. 30 added devices.

12. OTA

The device supports firmware updating through OTA, and will acquire new firmware from zigbee controller or hub every 10 minutes automatically.

13. Controlled by a push switch:

Once connected with a push switch, click the push switch to switch ON/OFF, press and hold down it to increase/decrease light intensity between 1% to 100%.

14. Minimum Brightness Setting

Set Minimum Brightness



Step 1: adjust the brightness of connected load to a desired level between 1%-50%.

Step 2: short press "Min. Set" key 3 times continuously and then within 2 seconds press and hold it for over 5 seconds until connected load blinks to set the brightness adjusted in step 1 as minimum brightness, then the load can not be dimmed below this level.

Delete Minimum Brightness



Step 1: adjust the brightness of connected load to 100%.

Step 2: short press "Min. Set" key 3 times continuously and then within 2 seconds press and hold it for over 5 seconds until connected load blinks to delete the previously set minimum brightness.

15. Startup Brightness Setting

Set Startup Brightness



Step 1: adjust the brightness of connected load to a desired level between 1%-50%.

Note: startup brightness setting function is to avoid the phenomenon that some dimmable LED drivers can not be turned on after turned off at a very low brightness level. Once setting a startup brightness, if the startup brightness is higher than the brightness before turned off, the driver will first go to the startup brightness after turned on then drop down to the level before turned off. If the startup brightness is lower than the brightness before turned off, the driver will directly go to the brightness before turned off.

Delete Startup Brightness



Step 1: adjust the brightness of connected load to 0%.

Step 2: short press "Min. Set" key 6 times continuously and then within 2 seconds press and hold it for over 5 seconds until connected load blinks to delete the previously set startup brightness.

Wiring Diagram

Notes for the diagrams:

L - terminal for live lead

N - terminal for neutral lead

⊗ - output terminal of the dimmer (controlling connected light source)

S - terminal for push switch

(1) 2-Wire Connection With No Neutral Lead

Single push switch wiring

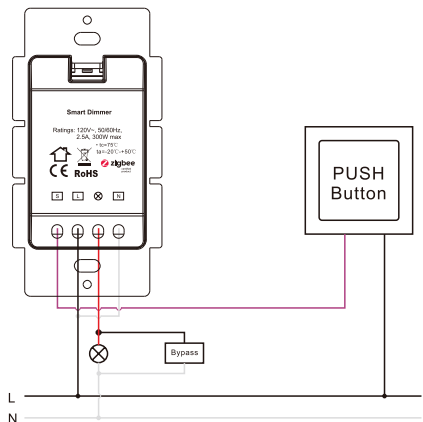

Multiple push switches wiring for multiple control points

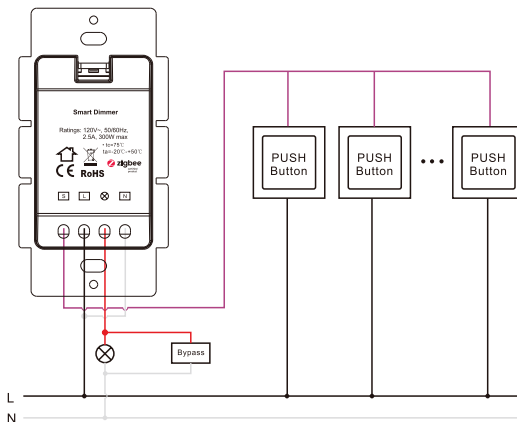

The Bypass is a device designed to work with the knob smart dimmer. It should be used in case of connecting LED bulbs or energy saving compact fluorescent lamps. The Bypass prevents flickering of the LED lights and glowing of the turned off compact fluorescent lamps. In the case of 2-wire connection, the Bypass allows to reduce minimum power of load required by the dimmer for correct operation. The Bypass provides powering of the dimmer in case of controlling the low loads of minimum power down to 3W (for $\cos\phi > 0.5$).

(2) 3-Wire Connection With Neutral Lead

Single push switch wiring

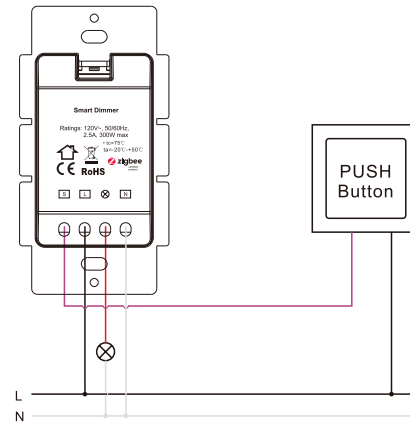

Multiple push switches wiring for multiple control points

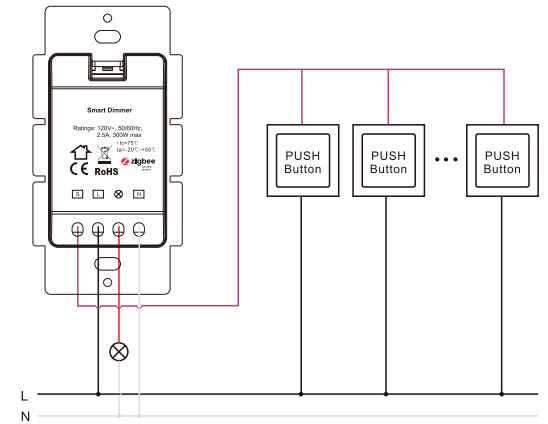

(3) With toggle on/off switch

2-Wire connection without neutral lead

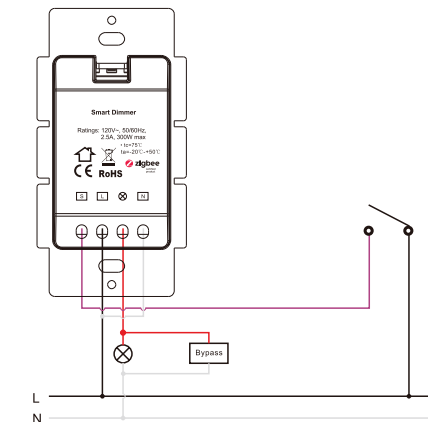

3-Wire connection with neutral lead

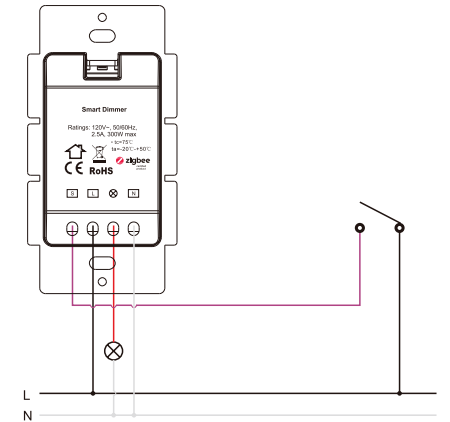

Supported Switch Types:

The switch types this device supports can be configured by factory setting:

1. Push Switch (factory default setting)
2. Toggle On/Off Switch (can be configured by factory setting upon request)

This phase dimmer adopts leading edge dimming (forward phase control) or trailing edge dimming (reverse phase control), two versions are available for choosing, factory default version is trailing edge. Please make sure the connected loads support the control type you choose. Please refer to the user manual of the load or consult the supplier of the load.

Installation

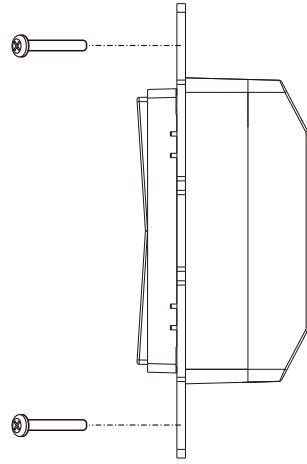
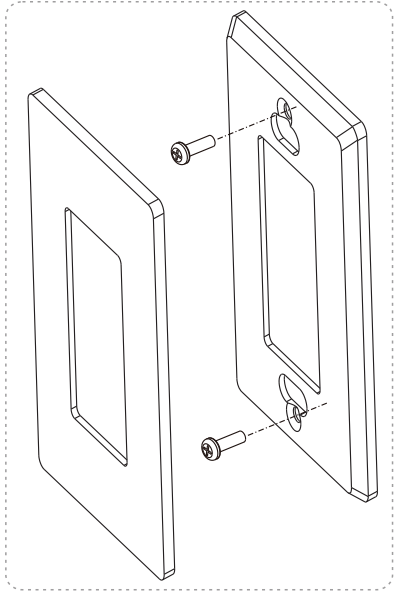

← Wallplate/Adapter purchased separately