

■ Feature

- Powered by high output OSRAM 2835 LED.
- Constant current.
- Integrated transparent 170° optic lens.
- 50 pcs per string.
- CE, RoHS,UL,TUV, BIS, CB and LM-80 certified.

■ Application

- Apply to 6-15 cm depth illuminated letter or light box at airports, metros, banks, buildings and shopping malls, etc.

■ Parameters

Items	Parameters			
Part Number	EV-BLUF01LBY-CW	EV-BLUF02LBY-CW	EV-BLUF03LBY-CW	EV-BLUF04LBY-CW
CCT (K)	6500K	6500K	6500K	6500K
Beaming Angle (°)	170°	170°	170°	170°
CRI (Ra)	≥80	≥80	≥80	≥80
Luminous Flux (lm)	50	100	150	200
Voltage (V)	DC12	DC12	DC12	DC12
Power (W)	0.5	1	1.5	2
Driving Method	Constant Current	Constant Current	Constant Current	Constant Current
Dimension (mm)	27.8*15.4*10.4	52.8*15.4*10.4	77.8*15.4*10.4	47.3*40.3*10.49
Working Tem. (°C)	-25 ~ +60	-25 ~ +60	-25 ~ +60	-25 ~ +60
Storage Tem. (°C)	-25 ~ +70	-25 ~ +70	-25 ~ +70	-25 ~ +70
Protection Grade	IP67	IP67	IP67	IP67

■ **Dimension (Unit:mm/inch)**

EV-BLUF01LBY-CW

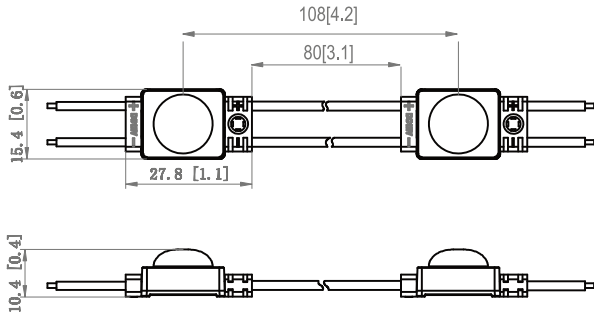

EV-BLUF02LBY-CW

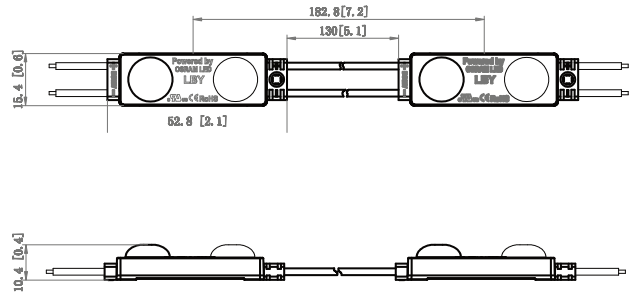

EV-BLUF03LBY-CW

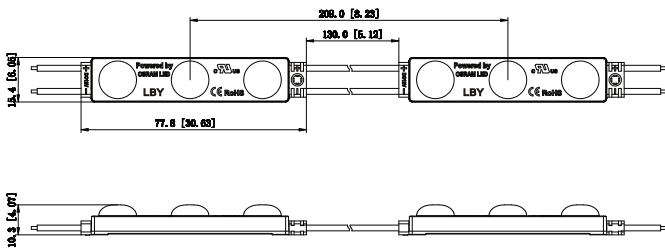

EV-BLUF04LBY-CW

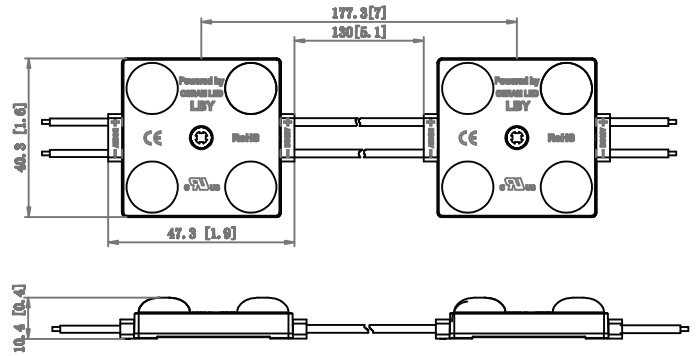

■ **Beaming Angle**

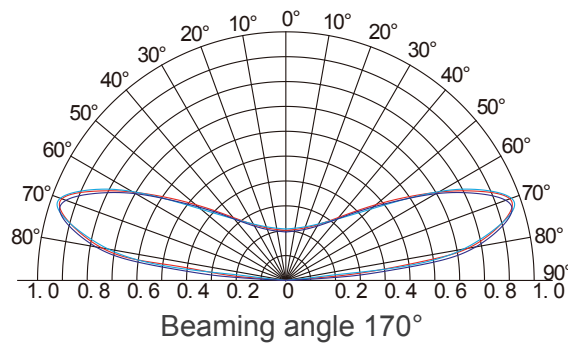

Reference Scheme

Part Number	Sizes(mm)	Area(m ²)	Distance(mm)	Quantities	Density(pcs/m ²)	Illumination(lux)
EV-BLUF02LBY-CW	510*480*60	0.24	80	33	138	6000-6500
	640*610*80	0.43	80	60	138	5000-5500

Part Number	Sizes(mm)	Area(m ²)	Distance(mm)	Quantities	Density(pcs/m ²)	Illumination(lux)
EV-BLUF03LBY-CW	510*480*60	0.24	130	20	84	2200-2500
	640*610*80	0.43	130	35	84	2000-2300

Remark:

01. The thickness of the acrylic white board of this case light box is 3mm, and the light transmittance is 54.4%..
02. This example illumination is the lowest uniform value of the surface of the thickness.
03. The above data is for reference only.

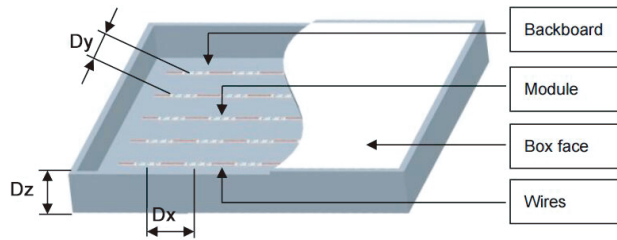

Wire Connection

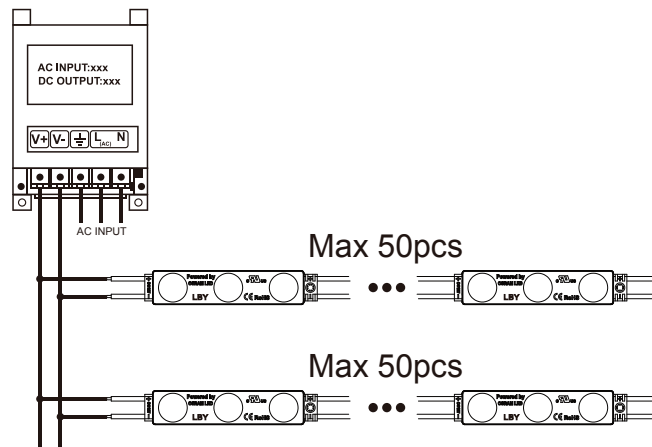

■ Packing

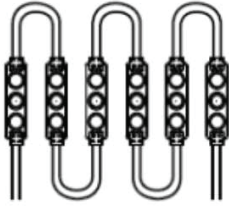

50pcs per string

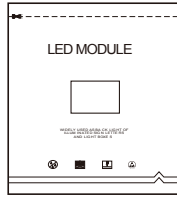

100pcs in an anti-static bag

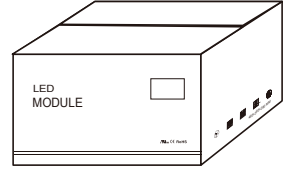

1000pcs in a carton

■ Packing Specification

- Antistatic bag adopted
- Packing information

Part Number	EV-BLUF01LBY-CW	EV-BLUF02LBY-CW	EV-BLUF03LBY-CW	EV-BLUF04LBY-CW
Carton Dimension (mm)	490*450*220	490*450*220	490*450*220	490*450*220
Bags Per Carton	10	10	10	10
Quantity Per Carton (pcs)	2000	1500	1000	1000
Net Weight (kg)	12(1±10%)	15(1±10%)	15(1±10%)	22(1±10%)
Gross Weight (kg)	13(1±10%)	16(1±10%)	16(1±10%)	23(1±10%)

Due to the packing manner difference, please adhere to the original products in case of discrepancy found between the picture and actual product.

■ Self-provided tools & material

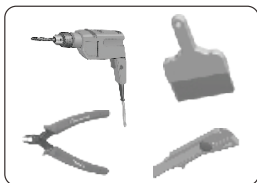

Dust brush, cutter, pencil, wire stripper, and drill



Wire Connector (Standard)



Screw

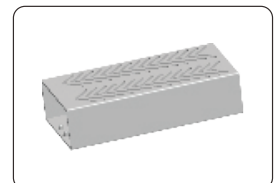

Power Supply

■ Installation Guidance

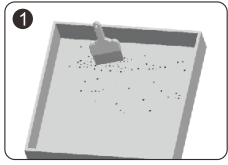

- Clean inside the light box.

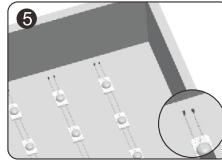

- Strip the end wire for 10mm and cap with the wire connector. Waterproof and anti-corrosion must be done on the connectors.

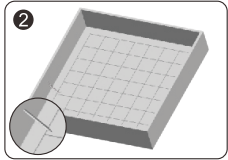

- Determine the appropriate layout.

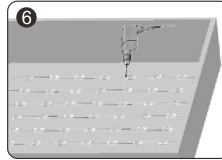

- Locate modules in the optimal position and secure with screws or neutral glass cement, which should be applied at the edge of the modules.
- ⚠ Note: Avoid breaking the module and wire when fixing with a drill.

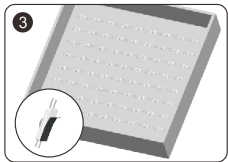

- Peel tape backing and stick modules into place.

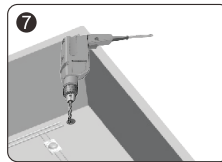

- Drill a hole for connecting power cable. Fixation and protection for the cable must be done on the hole.
- ⚠ Note: Avoid breaking the light box in drilling the hole.

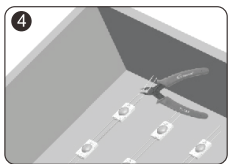

- Remove the unneeded modules.
- ⚠ Note: Cut in the middle position of the wires between modules.

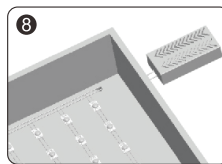

- Connect to the power cable and make sure that the polarity for connection is correct.
- ⚠ Note: Red wire is positive and black wire is negative.

■ Instructions

01. Disassembling or modifying the product is not allowed.
02. Installation with power on is not allowed.
03. Any organic solvent chemical is not allowed.
04. Acidic or alkaline adhesive is not allowed when install, neutral glass cement could be used for installation purpose, make it drying in open environment for four hours.
05. Isolation and corrosion prevention on all wiring points and wire ends.
06. Make sure the power wire is thick enough and ensure the voltage and connections are connected correctly before power on.
07. This product should be used in a sign, do not expose it in opening site.
08. Installation, maintaining should be done by professional staff.
09. 50 pcs in a serial connection maximum.
10. The power wire between power supply and module should be less than two meters to keep the same brightness on all parts.
11. Initial location with 3M tape, then secure with screws.

■ Declaration

01. Warranty: 7 years.
02. In order to ensure the safety, the broken wires need to be replaced by the manufacturer or the service agent, or by the staff with the similar qualification.
03. The given data in the specification was based on the laboratory testing, there may be discrepancy found in the actual products.
04. The given drawings in the specification are only for reference, there may be discrepancy found in the actual products.
05. The products are subject to change without prior notification.